

Einstein on light : from waves to quanta and back

U A Yajnik
Physics Department, IIT Bombay



August 26 2005

Outline

- From particles to waves
- “desperate measures” and a rooky’s quarrel with stalwarts
- “a heuristic view concerning emission and absorption of light”
- S N Bose – true character of light quanta
- What happened to waves?
- A philosophical epilogue

Newton's "spectrum"

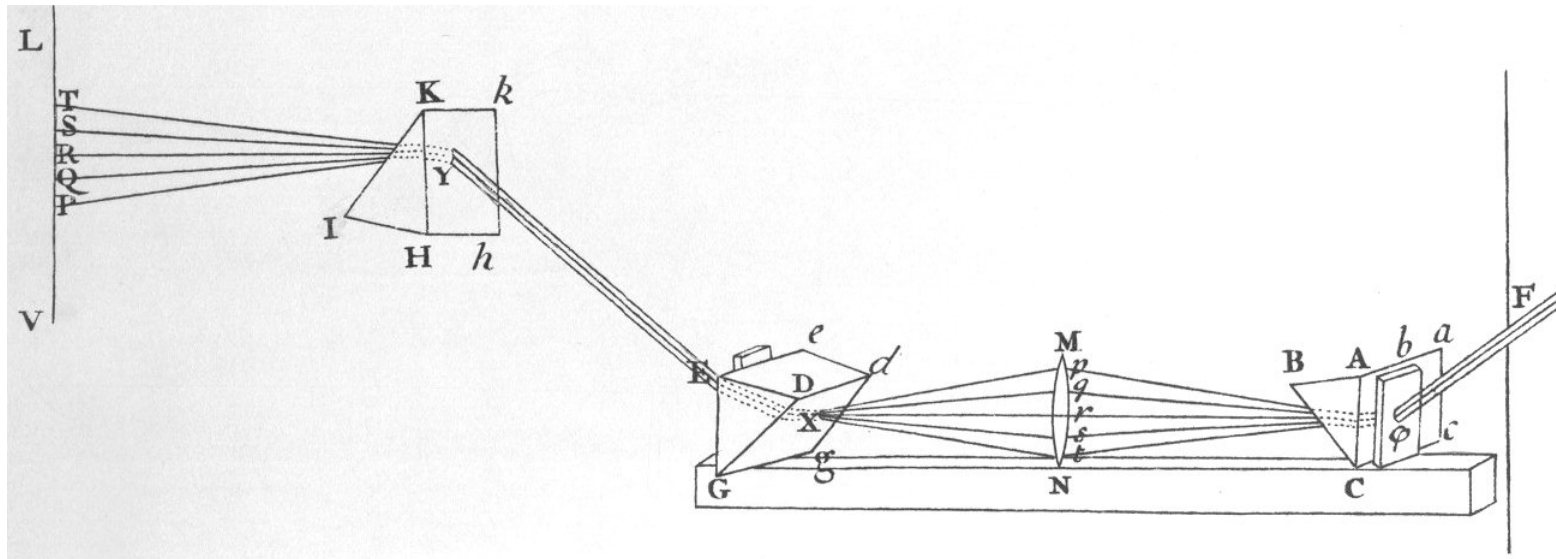

Particles of different colour assumed to travel with different speeds

Solar spectrum

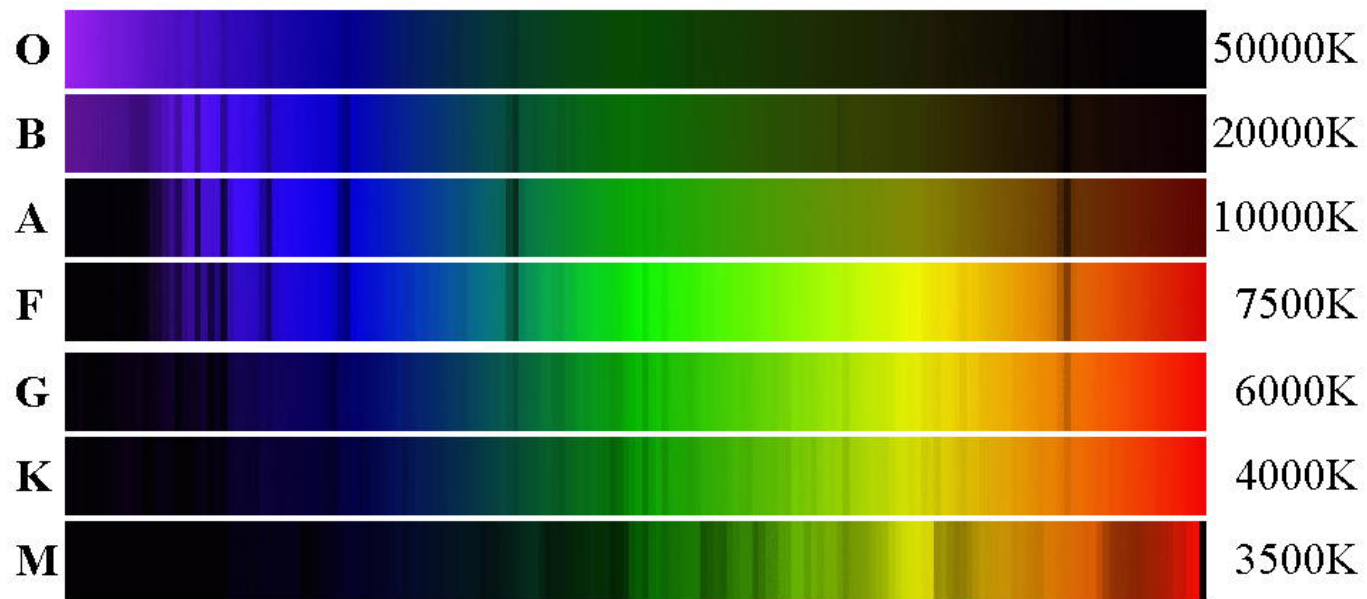

... But they are waves

Young and Fraunhofer

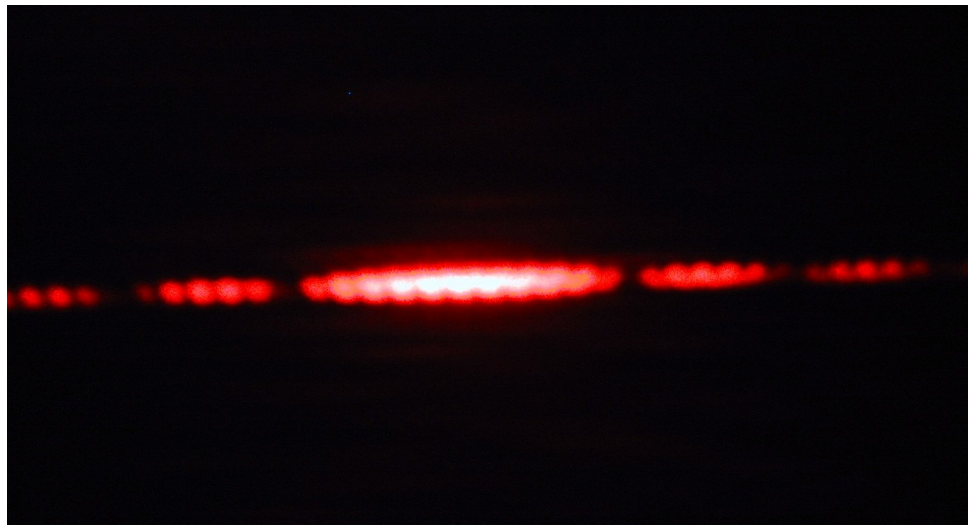

Interference and Diffraction in one

Huygens construction

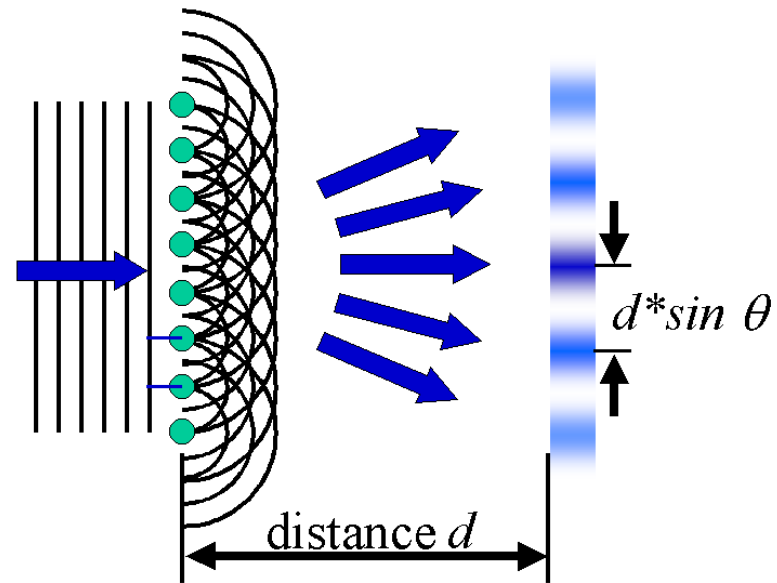

Glowing metals

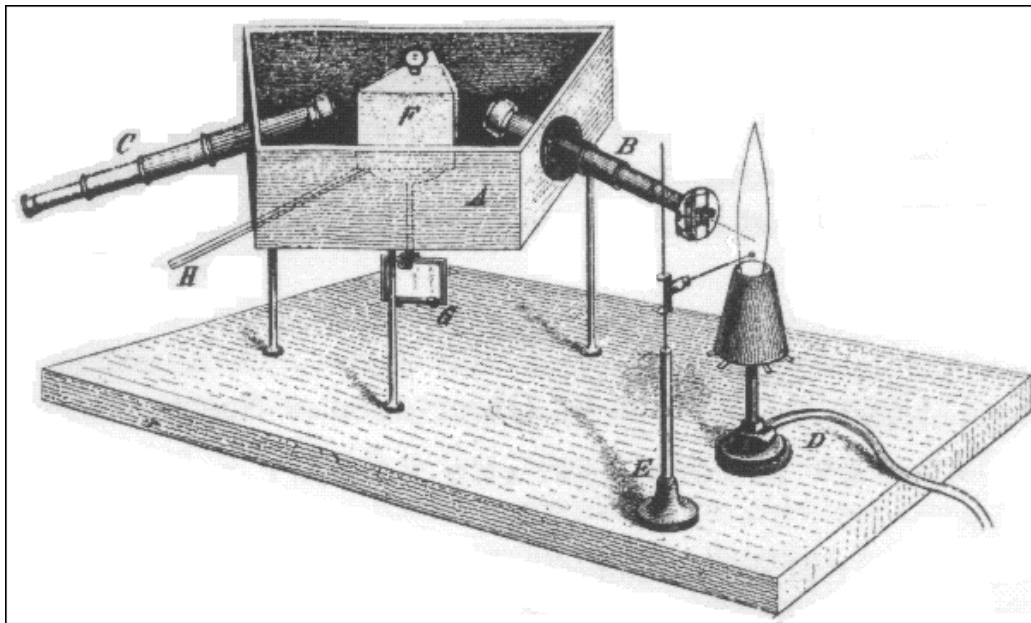

Spectroscope (1860)



Robert Bunsen

Complementarity of emission and absorption

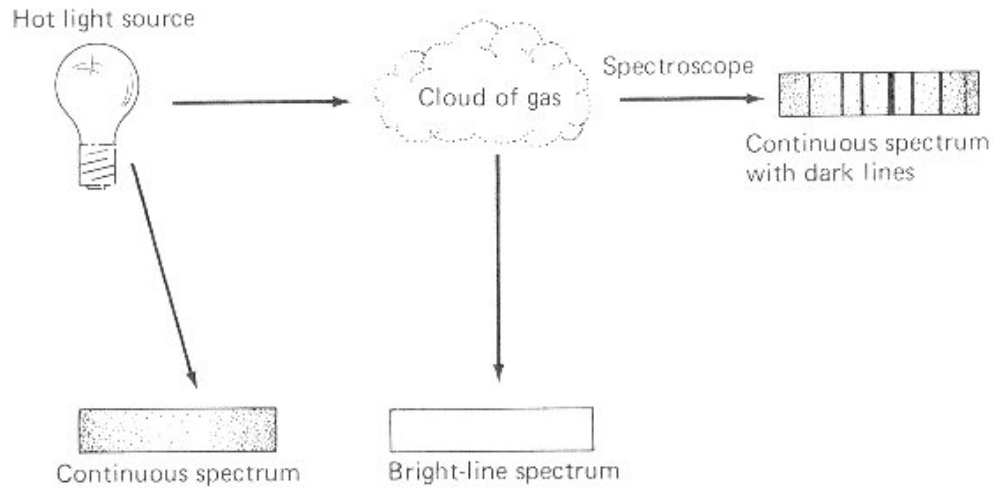

Gustav Kirchhoff

Kirchoff's challenge (1859)

To prove that the Emissivity of a glowing substance was a universal function only of its temperature.

More precisely,

$$\frac{\mathcal{E}(\nu)}{A_\nu} = J(\nu, T)$$

It is necessary to factor out the absorptivity A_ν . Ideal substance for which $A_\nu = 1$ is called Black Body. An enclosure with perfectly reflecting walls (and a small exit hole) is Black Body and is well approximated by a cavity made in a metallic block.

'An act of desperation ...

I had to obtain a positive result, under any circumstances and at whatever cost'

Planck, in 1931, recalling his situation in 1900

Reasonable conjectures

J. C. Maxwell's derivation of properties of radiation impinging on a mirror

$$p = \frac{1}{3}\rho$$

where p is pressure and ρ is the energy density in radiation

Stefan-Boltzmann law

$$\mathcal{E} = \sigma T^4$$

From this Wien was able to deduce the scaling law

$$\rho(\nu, T) = \nu^3 f(\nu/T)$$

and later, the reasonable fit to data, the famous Wein's Law (1896)

$$\rho(\nu, T) = \alpha \nu^3 e^{-\nu/\beta T}$$

Planck's formula

By 1900, Lummer and Pringsheim and separately, Rubens and Kurlbaum at Berlin were beginning to explore the spectrum into the far infrared.

Planck's formula

By 1900, Lummer and Pringsheim and separately, Rubens and Kurlbaum at Berlin were beginning to explore the spectrum into the far infrared.

M. Planck, relatively young had just joined the same university and was privy to the emerging results.

Planck's formula

By 1900, Lummer and Pringsheim and separately, Rubens and Kurlbaum at Berlin were beginning to explore the spectrum into the far infrared.

M. Planck, relatively young had just joined the same university and was privy to the emerging results.

(The chair at Berlin, vacant after Kirchoff's death was offered to L. Boltzmann and to H. Hertz both of whom turned down the chair, finally accepted by M. Planck :-))

Planck's formula

By 1900, Lummer and Pringsheim and separately, Rubens and Kurlbaum at Berlin were beginning to explore the spectrum into the far infrared.

M. Planck, relatively young had just joined the same university and was privy to the emerging results.

(The chair at Berlin, vacant after Kirchoff's death was offered to L. Boltzmann and to H. Hertz both of whom turned down the chair, finally accepted by M. Planck :-)

In October 1900 on a Sunday afternoon visit by the Rubens to the Plancks, Heinrich Rubens informs Planck that most likely,

$$\rho \propto T \quad \text{for } \nu \rightarrow 0$$

It seems this was the remark which electrified Planck into arriving at the law

$$\rho(\nu, T) = \frac{8\pi\nu^3}{c^3} \frac{1}{e^{h\nu/kT} - 1}$$

Note this becomes Wein's law for large ν and satisfies Rubens' hunch for small ν .

Thus the correct quantum formula was guessed after the *classical* (long wavelength) regime was explored better.

Cosmic microwave background radiation (CMBR)

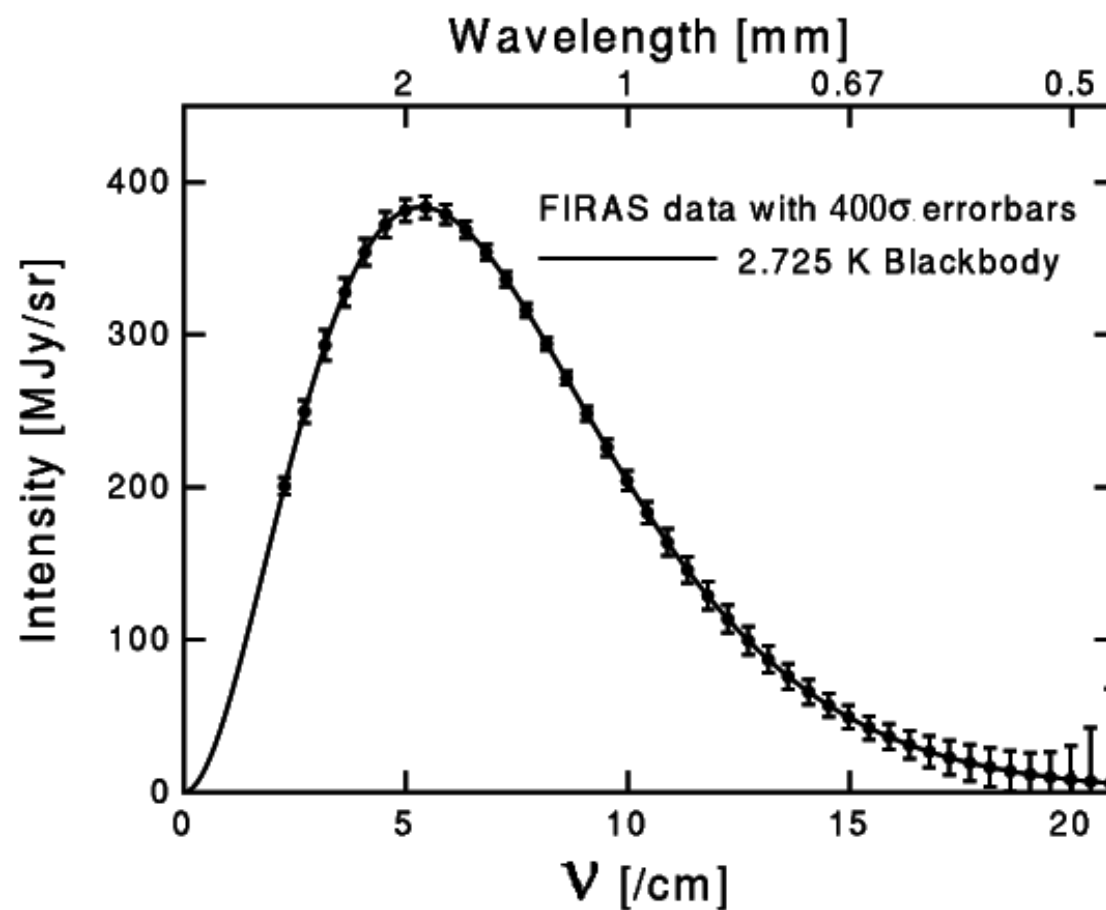

Planck's reasoning

By considering the radiation inside a Black Body to be in contact with a set of oscillators, and using Maxwell theory, Planck deduced

$$\rho(\nu, T) = \frac{8\pi\nu^2}{c^3} U(\nu, T)$$

(*)

where U is the equilibrium energy in an oscillator of intrinsic frequency ν . Using the thermodynamic connection $dU = TdS$ between internal energy, temperature and entropy, Planck then deduced the equilibrium entropy of the oscillator, $S(U/\nu)$

a peculiar distributing procedure

Planck assumes existence of “finite energy elements” ϵ , a total P of them distributed among N identical oscillators (for each frequency ν) such that

$$U_{total} = P\epsilon = U_1 + U_2 + \dots = NU_{equil}$$

More curiously, he assumes these to be distributed in an indistinguishable way among the oscillators. Here is an example with $N = 5, P = 23$

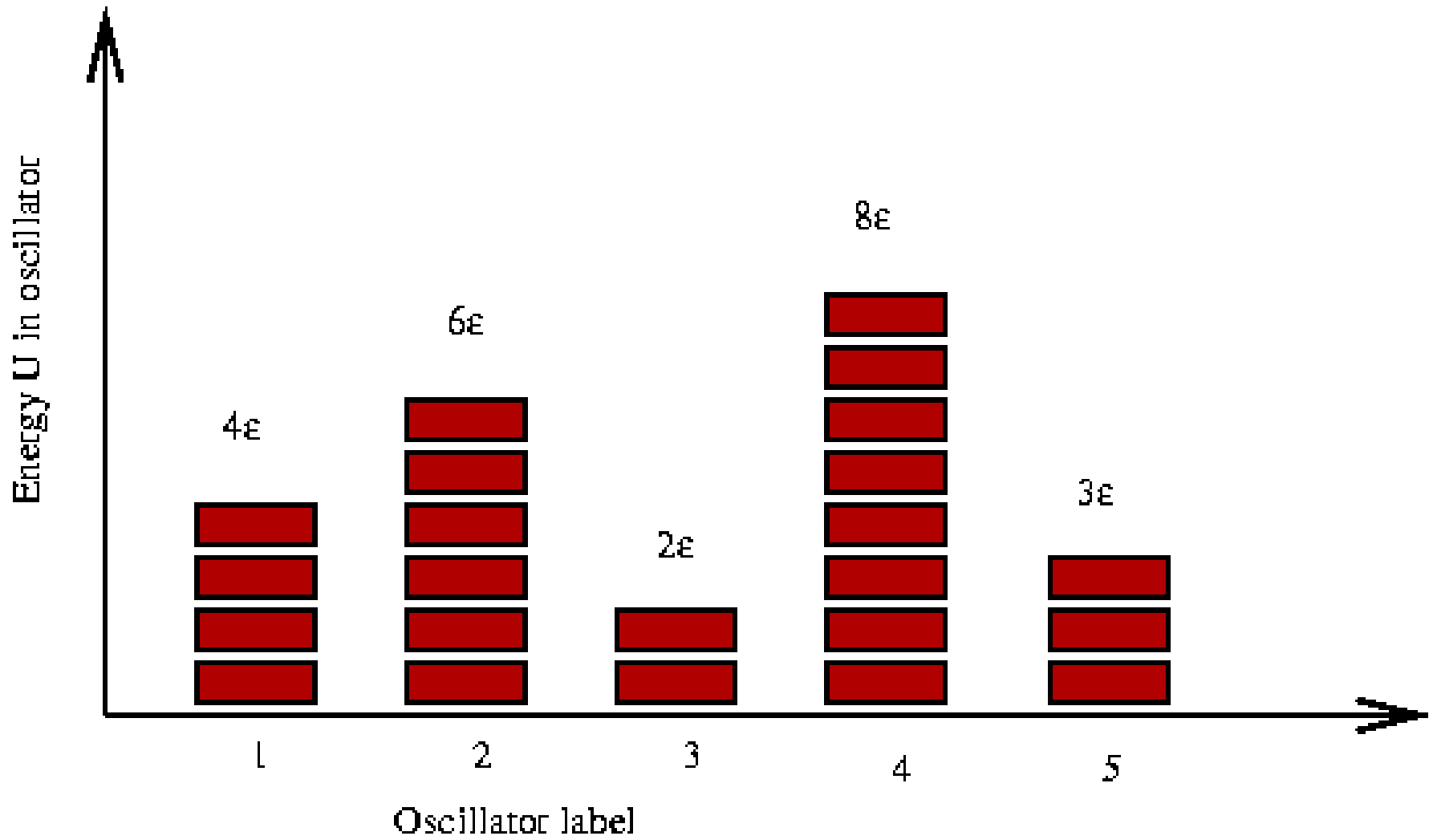

Assuming Boltzmann principle of equilibrium entropy as natural log of possible ways the system can configure itself, consistent with energy and other conservation rules,

$$S = k \ln W$$

he obtains an expression for S as a function of U_{total}/ϵ . Comparing the two formulae for entropy of an oscillator, on the one hand to fit his radiation formula and on the other hand to satisfy Boltzmann entropy but with peculiar filling rules, he deduces, for the oscillators, the rule

$$E = h\nu$$

(**)

Einstein's quarrel with the stalwarts

Einstein's "photoelectric" paper has only marginal interest in this effect, which at that time is not even properly measured. Two-thirds paper is devoted to something else!

"A profound formal difference exists between the theoretical concepts ... about gases and other ponderable bodies and Maxwell's theory of electromagnetic processes."

Einstein has issues to pick, (1) with Boltzmann's definition of entropy by counting of available states (2) Planck's derivation of energy distribution among oscillators. Returning to formula (*),

$$\rho(\nu, T) = \frac{8\pi\nu^2}{c^3} U(\nu, T)$$

he observes that instead of deducing results about U of oscillators from the radiation formula for ρ , one could apply this to ρ of radiation from Boltzmann's famous result $U = kT$ (for oscillator with 2 degrees of freedom). Now

$$\rho(\nu, T) = \frac{8\pi}{c^3} kT \nu^2$$

if this is to be believed, total energy in radiation will diverge. This gives cause for objection (2).

Entropy from equilibrium quantities

On the other hand, without recourse to counting of configurations and such, Einstein derives, purely from thermodynamic principles, the scaling law for the entropy with change of volume V at fixed temperature T of a system of N particles to be

$$S - S_0 = k \ln \left(\frac{V}{V_0} \right)^N$$

Mere application of Wein's radiation law, combined again with $d\rho = (T/V)dS$, he obtains S for the radiation gas,

$$S - S_0 = \frac{E}{\beta\nu} \ln \left(\frac{V}{V_0} \right)$$

By comparing, $N = \frac{E}{k\beta\nu}$. Since Planck formula fixes $\beta = h/k$, we have again,

$$E = h\nu$$

but now for the light “particles”, not the oscillators!!!

By comparing, $N = \frac{E}{k\beta\nu}$. Since Planck formula fixes $\beta = h/k$, we have again,

$$E = h\nu$$

but now for the light “particles”, not the oscillators!!!

Thus the hypothesis :

“Monochromatic radiation of low density behaves in thermodynamic respect as if it consists of mutually independent energy quanta of magnitude $\frac{R\beta\nu}{N}$ ” ($= h\nu$).

Quantum emission and absorption

Photoluminescence – Stokes Rule : frequency of emitted line is always less than that of the absorbed light

Photoelectric effect

$$E_{max} = h\nu - P$$

“According to the assumption considered here, in the propagation of a light ray emitted from a point source, the energy is not distributed continuously over ever-increasing volumes of space, but consists of finite number of energy quanta localised at points

of space that move without dividing, and can be absorbed and generated only as complete units ." (1905)



Einstein – waves and quanta

Reactions to light-quantum hypothesis :-)

Planck, Nernst, Rubens, ...(1913) recommending him to Prussian Academy :

“That he may have sometimes missed the target in his speculations, as, for example, in his hypothesis of light-quanta, cannot really be held against him ...”

Reactions to light-quantum hypothesis :-)

Planck, Nernst, Rubens, ...(1913) recommending him to Prussian Academy :

“That he may have sometimes missed the target in his speculations, as, for example, in his hypothesis of light-quanta, cannot really be held against him ...”

Einstein in true scientific spirit stands by the ambiguity without retracting (1911)

“I insist on the provisional character of this concept which does not seem reconcilable with the experimentally verified consequences of the wave theory.”

(Recall radio waves : Hertz, Marconi, J C Bose ...)

Millikan who managed the first clear experimental verification of the photoelectric law, writes in (1916) :

“... the bold, not to say reckless, hypothesis of an electromagnetic light corpuscle ...”

Millikan who managed the first clear experimental verification of the photoelectric law, writes in (1916) :

“... the bold, not to say reckless, hypothesis of an electromagnetic light corpuscle ...”

The Nobel citation (1922) refers to correct prediction of the photoelectric formula, not the underlying quantum hypothesis!!

S N Bose (1924)

Equipartition of identical particles among “cells” of size h^3 , with identical weightage for each cell (= each single-particle quantum state).

S N Bose (1924)

Equipartition of identical particles among “cells” of size h^3 , with identical weightage for each cell (= each single-particle quantum state).



Quantum indistinguishability = *count the independent*

states, not the particles !!!

Quanta are not particles !!

The states of photons and electrons

	CL	Q_{BE}	Q_{FD}
H H	$\frac{1}{4}$	$\frac{1}{3}$	0
H T	} $\frac{1}{2}$	} $\frac{1}{3}$	} 1
T H			
T T	$\frac{1}{4}$	$\frac{1}{3}$	0

What happened to the waves

Coherent states

E. C. G. Sudarshan (1963) and Bloembergen (1963)

There exist states of the many-photon quantum system, (the quantized electromagnetic field) in which the system behaves exactly like the classical waves.

- ✓ Field operator has exact measurable real values
- ✓ Magnitude of fluctuations / average value $\rightarrow 0$

What happened to the waves

Coherent states

E. C. G. Sudarshan (1963) and Bloembergen (1963)

There exist states of the many-photon quantum system, (the quantized electromagnetic field) in which the system behaves exactly like the classical waves.

- ✓ Field operator has exact measurable real values
- ✓ Magnitude of fluctuations / average value $\rightarrow 0$

We thus have peaceful coexistence of waves ...

What happened to the waves

Coherent states

E. C. G. Sudarshan (1963) and Bloembergen (1963)

There exist states of the many-photon quantum system, (the quantized electromagnetic field) in which the system behaves exactly like the classical waves.

- ✓ Field operator has exact measurable real values
- ✓ Magnitude of fluctuations / average value $\rightarrow 0$

We thus have peaceful coexistence of waves ... with quanta (not corpuscles !!)

Philosophical issues

- **Principle of Statistics**

Einstein has serious objections to Boltzmann's method of counting all possible configurations. This seems to be based on the idea that enumerating all the configurations with correct weightage requires the knowledge of *dynamics*, not mere geometric allocation into phase space bins.

To Boltzmann, each particle had a distinct identity (even though indistinguishable from neighbours). Thus snapshots of motion were as good as motion itself.

Einstein felt this was stretching things beyond the common-sense notions of probability.

Instead, he developed methods which permitted calculation of fluctuations using standard thermodynamic functions, thus not invoking Statistical Mechanics.

Einstein's caution seems profound in retrospect ...

Einstein felt this was stretching things beyond the common-sense notions of probability.

Instead, he developed methods which permitted calculation of fluctuations using standard thermodynamic functions, thus not invoking Statistical Mechanics.

Einstein's caution seems profound in retrospect ...

eventually we know quanta do not have identity in Boltzmann's sense.

Einstein felt this was stretching things beyond the common-sense notions of probability.

Instead, he developed methods which permitted calculation of fluctuations using standard thermodynamic functions, thus not invoking Statistical Mechanics.

Einstein's caution seems profound in retrospect ...

eventually we know quanta do not have identity in Boltzmann's sense.

Einstein's caution hurt his progress ...

Einstein felt this was stretching things beyond the common-sense notions of probability.

Instead, he developed methods which permitted calculation of fluctuations using standard thermodynamic functions, thus not invoking Statistical Mechanics.

Einstein's caution seems profound in retrospect ...

eventually we know quanta do not have identity in Boltzmann's sense.

Einstein's caution hurt his progress ...

Reluctantance to use the method of configurations perhaps prevented him from recasting his own argument parallel to Planck's, along the way S N Bose did two decades later.

- **Profound difference ...**

Einstein was complaining about Formal difference and proposing quanta ... Einstein was also proposing in the same year, Special Relativity asserting completeness of Maxwell-Lorent formulation.

- **Profound difference ...**

Einstein was complaining about Formal difference and proposing quanta ... Einstein was also proposing in the same year, Special Relativity asserting completeness of Maxwell-Lorent formulation.

More curiously, Einstein does not seem to have been deterred by the following question : If the emission is in a pointlike form, which direction does the emission occur in?

- **Profound difference ...**

Einstein was complaining about Formal difference and proposing quanta ... Einstein was also proposing in the same year, Special Relativity asserting completeness of Maxwell-Lorent formulation.

More curiously, Einstein does not seem to have been deterred by the following question : If the emission is in a pointlike form, which direction does the emission occur in?

In other words, the emitter must select an arbitrary direction – violation of rotational invariance

- **Profound difference ...**

Einstein was complaining about Formal difference and proposing quanta ... Einstein was also proposing in the same year, Special Relativity asserting completeness of Maxwell-Lorent formulation.

More curiously, Einstein does not seem to have been deterred by the following question : If the emission is in a pointlike form, which direction does the emission occur in?

In other words, the emitter must select an arbitrary direction – violation of rotational invariance

This can only be saved by the subsequent probabilistic interpretation of predictive capability of Quantum Mechanics. Einstein had himself sown the seeds of probabilistic interpretation which he fought against, the rest of his life.

Epilogue in lieu of conclusion

- Einstein was ahead of his time; it remained for others to carry forward Quantum Theory, whose final form Einstein could not agree with
- Simplest understanding of quanta :
 - Quanta are not particles!!
 - Unusual states – symmetric or antisymmetric
 - ... begs the question “why are there identical particles?”

Epilogue in lieu of conclusion

- Einstein was ahead of his time; it remained for others to carry forward Quantum Theory, whose final form Einstein could not agree with
- Simplest understanding of quanta :
 - Quanta are not particles!!
 - Unusual states – symmetric or antisymmetric
 - ... begs the question “why are there identical particles?”
- For photons by themselves, the field and quantum pictures merge seamlessly through the construct of coherent states.

- Special Relativity and Quantum Theory harmoniously brought together in the Theory of Quantized Fields
 - “Formal differences” finally resolved with advent of Quantum Electrodynamics of Feynman, Schwinger and Tomonaga. Both electrons (“ponderable”) and photons are on the same footing.

- Special Relativity and Quantum Theory harmoniously brought together in the Theory of Quantized Fields
 - “Formal differences” finally resolved with advent of Quantum Electrodynamics of Feynman, Schwinger and Tomonaga. Both electrons (“ponderable”) and photons are on the same footing.
- Electromagnetism ie Quantum Electrodynamics is found to be intertwined with Weak nuclear interaction; Strong nuclear force is of identical mathematical structure, with different strength of coupling. A complete QFT description exists for all of these : the Standard Model of Elementary Particles

- Special Relativity and Quantum Theory harmoniously brought together in the Theory of Quantized Fields
 - “Formal differences” finally resolved with advent of Quantum Electrodynamics of Feynman, Schwinger and Tomonaga. Both electrons (“ponderable”) and photons are on the same footing.
- Electromagnetism ie Quantum Electrodynamics is found to be intertwined with Weak nuclear interaction; Strong nuclear force is of identical mathematical structure, with different strength of coupling. A complete QFT description exists for all of these : the Standard Model of Elementary Particles
- Quantum Theory of Gravity does not seem to be QFT in the usual sense. It seems to demand Superstring Theory

- Special Relativity and Quantum Theory harmoniously brought together in the Theory of Quantized Fields
 - “Formal differences” finally resolved with advent of Quantum Electrodynamics of Feynman, Schwinger and Tomonaga. Both electrons (“ponderable”) and photons are on the same footing.
- Electromagnetism ie Quantum Electrodynamics is found to be intertwined with Weak nuclear interaction; Strong nuclear force is of identical mathematical structure, with different strength of coupling. A complete QFT description exists for all of these : the Standard Model of Elementary Particles
- Quantum Theory of Gravity does not seem to be QFT in the usual sense. It seems to demand Superstring Theory

- Is this the ultimate structure of matter and energy?

- Is this the ultimate structure of matter and energy?

Einstein would certainly have been interested in the answer !!!

References

1. "Subtle is the Lord" Abraham Pais, Oxford U. Press 1984
2. "Annus Mirabilis – Einstein's miraculous year", John Stachel, Ed.
3. Newton to Einstein: The Trail of Light by Ralph Baierlein (Cambridge University Press, 1992).
4. JAY E. NEWMAN R. Gordon Gould Professor of Physics Department of Physics Union College Schenectady, NY 12308
5. Â Leonard Fretzin 2000. <http://home.att.net/~ifretzin>
6. <http://www.physik.uni-mainz.de/quantum/bec/gallery/>

7. A high resolution version of the spectrum of our Sun, Solar Facility at Kitt Peak National Observatory, near Tucson, Arizona.
8. The Colours of the Stars - Astronomical Spectroscopy. Dr. John White (Talk given at Auckland Observatory Mon 12 May 2003 by Dr John C.B. White)
9. The Engines of Our Ingenuity is Copyright © 1988-2003 by John H. Lienhard.